

The logo for Atlantic Oase features a stylized white swirl icon on the left, followed by the word "Atlantic" in a bold, sans-serif font, a vertical line separator, and the word "Oase" in a similar font with a white leaf-like flourish above the letter 'e'.

# Atlantic<sup>®</sup> | Oase

## HARDSCAPE CATALOG

A photograph of a stone wall water feature at dusk. The wall is constructed from stacked, light-colored stones. Several arched openings in the wall allow water to flow out, creating multiple waterfalls. The water is illuminated with a blue light. In the background, a fire pit with flames is visible behind another stone wall. A wooden deck and a path of dark stones lead towards the water feature.

[www.ATLANTIC-OASE.com](http://www.ATLANTIC-OASE.com)



**FS**

# FORMAL SPILLWAY

Atlantic's Formal Spillway System makes easy work of adding the charm of running water to new or existing landscape or hardscape walls. Minimal noise and splash make this system ideal for indoor applications. Convenient Basin Kits include everything needed for installation, saving time and money. All components are matched for perfect performance every time.

- » Double filter mats keep debris out of the system, eliminating time consuming cleanouts
- » Basin Kits require no guesswork for installation and accommodate four spillway options
- » Dimensions of basins work well with all engineered stone systems
- » High efficiency pumps and top quality components keep cost of operation minimal
- » Water flow is adjustable to achieve the perfect effect regardless of location
- » The rigid basins are completely weatherproof and carry a lifetime warranty





## FORMAL SPILLWAY BASIN KITS



73849



73850



73851

- The heart of Atlantic Formal Spillway Systems, Basin Kits provide everything you need to install Colorfalls, WaterWalls and Spillways
- Three sizes of self-contained basins, complete with pumps and plumbing, accommodate 12, 24 and 36-inch Formal Spillways

- Seamless installation with four-inch garden block
- Basin Kits include basin, Splash Mat, pump, plumbing, PVC glue, adjustment valve and Auto Fill, all in one box

ITEM	73849	73850	73851
MODEL	CFBASINKIT12	CFBASINKIT24	CFBASINKIT36
DESCRIPTION	Complete Basin Kit for 12" Spillways	Complete Basin Kit for 24" Spillways	Complete Basin Kit for 24" Spillways
FOR USE WITH	All 6" & 12" Spillways	All 24" Spillways	All 36" Spillways
DIMENSIONS	20"W x 20"D x 16"H	44"W x 22"D x 16"H	56"W x 24"D x 16"H
PUMP	TT1500	TT3000	TT4000
WARRANTY	Basin - Lifetime / Pump - 3-year		

## TECH TIP

Atlantic's Basin Kits come with everything needed to create a fully functioning water feature with any single Formal Spillway. Simply choose the appropriate width Basin Kit. For multiple Spillway installations, double or triple Wall Spout installations or Spillway and double Spout installations, you will need to add tees and valves and create a manifold to accommodate the additional water outlets. See the Technical Data section on page 23 for valved manifold examples.

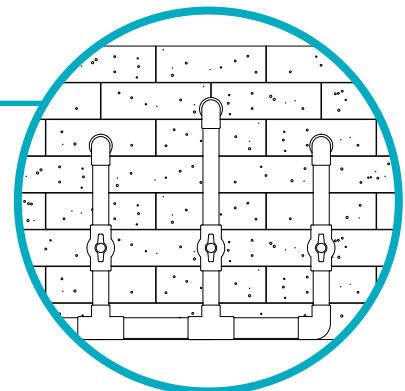





# FLEXIBLE HARDSCAPE BASINS & KIT



73836  
73839  
73842

73837  
73840  
73843

73838  
73841  
73844

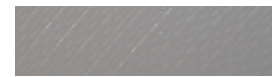

- For those applications that require an open basin, Atlantic's Flexible Basins are the easiest way to waterproof your block installation
- Reinforced 28mil PVC construction with fold out flaps and punched glue points anchor liner under capstones for security and durability
- Unlike improvised EPDM liner basins, welded corner construction eliminates folds and wrinkles for a neat professional appearance
- Basins are available in tan, grey and black to complement any surround up to eight-feet wide
- Includes backing plates and bulkheads for submersible or external pumps. Use Cord Seal Fittings to pass cords
- Perfect for use with Atlantic Spillways, WaterWalls and Wall Spouts, not recommended for Colorfalls installations without a FiltoClear

ITEM	73836	73837	73838	73839	73840	73841	73842	73843	73844
MODEL	FF4216B	FF4216G	FF4216T	FF6216B	FF6216G	FF6216T	FF8216B	FF8216G	FF8216T
DESCRIPTION	4' x 2' Flexible Hardscape Basin			6' x 2' Flexible Hardscape Basin			8' x 2' Flexible Hardscape Basin		
COLOR	Black	Grey	Tan	Black	Grey	Tan	Black	Grey	Tan
FOR USE WITH	Spillways, WaterWalls & Wall Spouts								
DIMENSIONS	4'W x 2'D x 16"H			6'W x 2'D x 16"H			8'W x 2'D x 16"H		
CAPACITY	80 gallons			120 gallons			160 gallons		
BULKHEAD	1½" w/ Backing Plate			(2) 1½" w/ Backing Plates					
WARRANTY	1-year								



# COPPER SPILLWAY BOWLS



73854



73853



73803

- Spillway Bowls complement any hardscape, landscape or poolscape with the elegance of copper
- Atlantic Copper Spillway Bowls are crafted out of solid copper in both round and square styles
- Copper Spillway Bowls are designed to form a natural patina over time
- All spillways are sized at 12" for maximum water flow and visual effect
- All Bowls feature dual 1½" FIPT inlets and solid copper standpipe for lighting and water supply

- Dual inlets allow water supply to be plumbed independently from lighting cords. Use Atlantic's Cord Seal Fitting to pass the light cord into the Bowl through the second inlet
- Solid Copper Pedestal accessory allows Bowls to be elevated 8"
- Copper Spillway Bowls are designed to work with the CFBASINKIT12
- Use a 12" Splash Ring on the 12" Formal Spillway Basin to control splash

ITEM	73854	73853	73803
MODEL	CB26S12	CB26R12	CB16P
DESCRIPTION	26" Square Copper Bowl w/ 12" Spillway	26" Round Copper Bowl w/ 12" Spillway	Copper Pedestal for Copper Bowls
FLOW RATE	1,200 gph		---
INLET	(2) 1½" FIPT		---
DIMENSIONS	26"W x 27½"D x 10"H		16"L x 16"W x 8"H
WARRANTY	3-year		

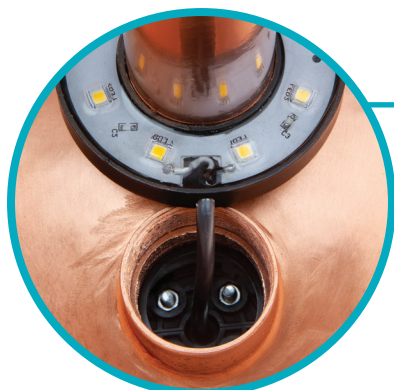

## TECH TIP

Copper Bowls lend themselves to a number of lighting options. External Spotlights are a great way to accent water overflowing the 36" Copper Bowl or the concentrated flow from spillways. Inside the bowl, the submersible Ring Light creates rippling uplighting effects on overhanging trees or structures. Install Atlantic's unique Cord Seal Fitting to make lighting inside the Bowl possible without a visible cord coming over the edge. The rubber fitting installs in the off-center 1½" FIPT inlet and expands when tightened, sealing the cord and the inlet.





# WALL SPOUTS



73867 (Copper)  
73871 (Bronze)



73869 (Copper)  
73873 (Bronze)



73870 (Copper)  
73875 (Bronze)



73868 (Copper)  
73872 (Bronze)

- Wall Spouts are an easy and elegant way to add the sight and sound of water to vertical surfaces
- Atlantic Wall Spouts complement larger spillways when paired; use alone to accent smaller spaces
- Solid brass fixtures add a captivating focal point to both traditional and contemporary walls and patios
- Choose from four architectural designs with oil rubbed bronze or antique copper finish to fit any style
- Integrated drip edge prevents water from backflowing down the wall
- Includes grounding lug for bonded systems

ITEM	73867	73871	73869	73873	73870	73875	73868	73872
MODEL	WSCM-S	WSM-S	WSCR-O	WSR-O	WSCV-S	WSV-S	WSCO-O	WSO-O
DESCRIPTION	Mantova Wall Spout		Ravenna Wall Spout		Verona Wall Spout		Olivett Wall Spout	
FINISH	Copper	Bronze	Copper	Bronze	Copper	Bronze	Copper	Bronze
FLOW RATE	600 gph							
PROJECTION*	14" - 16" at 18"H & 600 gph							
INLET	1½" FIPT							
DIMENSIONS	5"W x 4¾"D x 5"H		5"W x 5¼"D x 6"H		7"W x 4¾"D x 7"H		6"W x 4½"D x 5"H	
WARRANTY	3-year							

\* Projection is measured from the face of the wall the Spout is mounted on

## TECH TIP

Atlantic's unique Spout Lights illuminate the water from inside the plumbing. With 600 gallons per hour or more, the minimum flow required to submerge the light fixture in the plumbing, light is carried inside the laminar water flow.

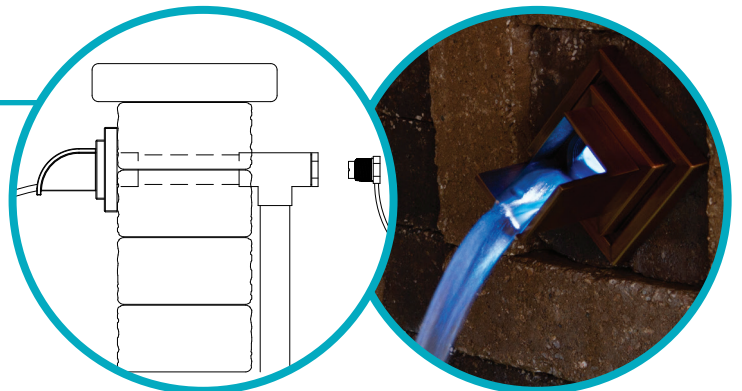





# SPILLWAYS

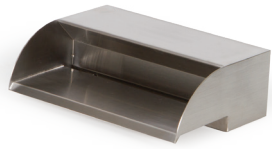

73858  
73859

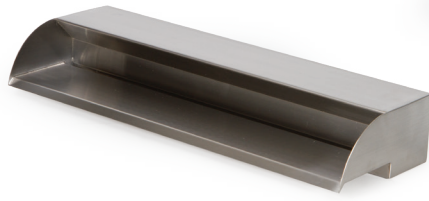

73860  
73861

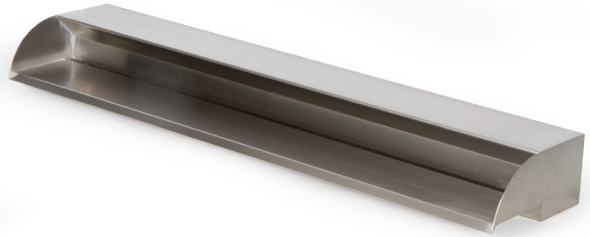

73862  
73863



73855



73856



73857

- 304 Stainless Steel Spillways provide an enticing and durable focal point for fresh water applications in the hardscape
- 316 Stainless Steel Spillways enhance any vertical wall in poolsapes, hardscapes and wherever chlorine is used as a disinfecting agent
- Atlantic's copper finish and brushed stainless Spillways feature heavy-gauge construction for ageless durability
- Spillways replace 4-inch wall blocks for easy and convenient installation in standard wall block construction without cutting
- Lively, energetic water flow enhances any vertical wall installation
- Load bearing body design supports 80 lbs. per linear foot for trouble free installations
- Non-clogging weir reduces maintenance in open basin applications

ITEM	73858	73859	73855	73860	73861	73856	73862	73863	73857
MODEL	SS12	SS12-316	CS12	SS24	SS24-316	CS24	SS36	SS36-316	CS36
DESCRIPTION	12" 304 Stainless Steel Spillway	12" 316 Stainless Steel Spillway	12" 304 Copper Finish Spillway	24" 304 Stainless Steel Spillway	24" 316 Stainless Steel Spillway	24" 304 Copper Finish Spillway	36" 304 Stainless Steel Spillway	36" 316 Stainless Steel Spillway	36" 304 Copper Finish Spillway
FLOW RATE	1,200 gph			2,400 gph			3,600 gph		
PROJECTION*	9" - 10" at 18"H & 1,200 gph			9" - 10" at 18"H & 2,400 gph			9" - 10" at 18"H & 3,600 gph		
INLET	1½" FIPT								
DIMENSIONS	12"W x 8½"D x 4"H			24"W x 8½"D x 4"H			36"W x 8½"D x 4"H		
WARRANTY	3-year								

\* Projection is measured from the face of the wall the Spillway is installed in





## COLOR CHANGING COLORFALLS

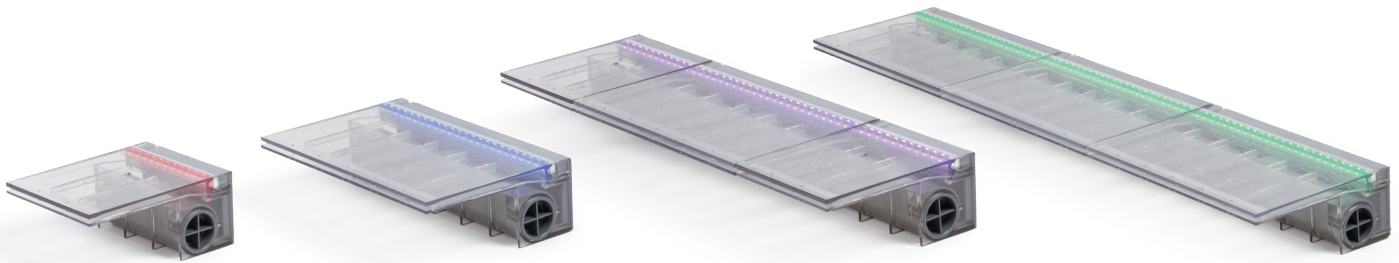

**73878**

**73879**

**73880**

**73881**

- Illuminated waterfalls are the most versatile way to add light and water to your landscape or hardscape
- Atlantic's Color Changing Colorfalls are the first modular sheer descent system with multiple light and configuration options
- Design custom colors, select transitions and create personalized sequences with the InfiColor Smart Module and Atlantic Control App
- Unlike other sheer descent waterfalls, Atlantic Color Changing Colorfalls may be linked together to create waterfalls of any width
- Synchronize multiple Colorfalls with InfiColor Smart Module (CCSM30X3) and a larger transformer
- Designed to install easily in any wall, indoors or out, whether stone, brick, block, stucco, tile or wood
- Atlantic's Color Changing Colorfalls' modular body style offers multiple inlets for maximum plumbing flexibility
- Generous weir openings resist clogging and create a thicker, fuller sheer for extra color and less wind deflection
- Colorfalls feature a 5" lip, 20' power cord and includes single outlet InfiColor Smart Module and 12V outdoor transformer
- For use with Formal Spillway Basins and Basin Kits

ITEM	73878	73879	73880	73881
MODEL	CC06	CC12	CC24	CC36
DESCRIPTION	6" Color Changing Colorfalls	12" Color Changing Colorfalls	24" Color Changing Colorfalls	36" Color Changing Colorfalls
FLOW RATE	600 gph	1,200 gph	2,400 gph	3,600 gph
PROJECTION*	8" - 10" at 18"H & 600 gph (Rec. Height: 20" max.)	8" - 10" at 18"H & 1,200 gph (Rec. Height: 20" max.)	8" - 10" at 18"H & 2,400 gph (Rec. Height: 30" max.)	8" - 10" at 18"H & 3,600 gph (Rec. Height: 40" max.)
INPUT VOLTAGE	InfiColor			
TRANSFORMER	10 watt (included)		20 watt (included)	
WATTS	3	5	10	15
INLET	1½" FIPT			
DIMENSIONS	6"W x 8"D x 3½"H	12"W x 8"D x 3½"H	24"W x 8"D x 3½"H	36"W x 8"D x 3½"H
WARRANTY	1-year			

\* Projection is measured from the face of the wall the Colorfalls is installed in



## COLOR CHANGING COLORFALLS FEATURES:

1. Large weir opening produces a thick sheer for less wind deflection, more color and less chance of clogging.
2. Internal lip supports eliminate splitting of the water sheer.
3. 1½" FIPT inlets on both sides and back for maximum plumbing options and versatility.
4. Includes (2) 1½" plugs for unused plumbing inlets.
5. Self-draining body for easy winterization.
6. Removable baffle for easy cleaning and servicing.
7. Color Changing LED light bar is accessible from the rear of the unit for servicing.
8. Removable back plate provides access to the interior and light bar for routine maintenance.
9. Threaded adapter with silicone O-rings to connect multiple Color Changing Colorfalls.

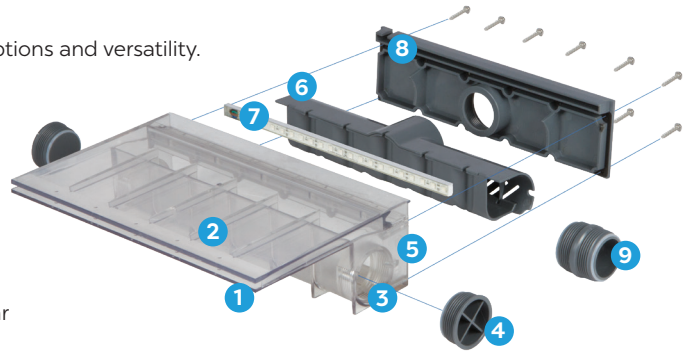

## SINGLE-ZONE INFICOLOR SMART MODULE & ATLANTIC CONTROL APP



The Inficolor Smart Module and Atlantic Control mobile application, the heart of the new Color Changing Lighting System, allow users to program custom color sequences and transitions, set sequence timing and daily scheduling and unlock all RGB options on any Apple or Android mobile device.

- Every Color Changing Colorfalls includes Single-zone Inficolor Smart Module
- Smart Module is wirelessly controlled via Atlantic Control App to unlock the full potential of Color Changing Lights, no remote necessary



The Bluetooth® Atlantic Control App makes custom colors, sequences, transitions, timing and daily scheduling of your Atlantic Color Changing Lighting or Color Changing Colorfalls accessible on any Apple and Android mobile device, no remote necessary.

- Choose any color visually or create a custom color with RGB sliders
- Combine and save custom color sequences as Favorites
- Assign one of five transitions and adjust the speed of any Favorite
- Adjust brightness of sequences and solid colors if desired
- Built in timer function controls daily on and off times for LEDs
- Atlantic Control App available on all Apple and Android devices

## DID YOU KNOW?



Thinking of adding a Color Changing Colorfalls to a new or existing hardscape? Check out our new Color Changing Colorfalls Project Bundle which includes everything needed to add the basin, plumbing, Colorfalls and even an Auto Fill! You choose the block, we provide the equipment!



FS

CAD

3D

## WATERWALL SPILLWAYS



**73877**

- Unique back-angled spout directs water downwards and onto wall below plumbing connection, to eliminate leaks, unwanted humidity and splash
- Revolutionary concept of spillway as a decorative focal point eliminates the need for valances
- Heavy-gauge 316 stainless steel construction ensures durability under even the harshest conditions

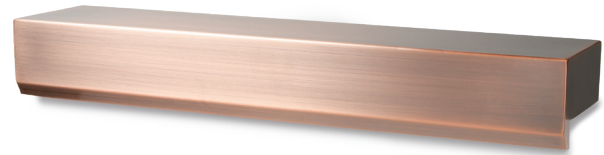

**73876**

- Bottom inlet accommodates wood-framed walls with masonry façades up to 1½" thick
- For masonry walls, cut channel in block below water wall to accommodate plumbing
- 1½" female threaded inlet and center rear bonding lug facilitate hidden in-wall plumbing connections

ITEM	73877	73876
MODEL	SWS24-316	CWS24-316
DESCRIPTION	24" Stainless Steel WaterWall Spillway	24" Copper Finish WaterWall Spillway
FINISH	Brushed Stainless	Antique Copper
FLOW RATE	Smooth Surfaces - 750-1500 gph / Rough Surfaces - 1500-3000 gph	
INLET	1½" FIPT	
DIMENSIONS	24"W x 5¼"D x 3½"H	
WARRANTY	3-year	

## DID YOU KNOW?

A new concept in water wall design, Atlantic's WaterWall Spillways eliminate the need for valances with an attractive stainless steel or copper finish that can be left visible, simplifying installation. Modular vertical spillways create water walls and weeping walls of any width in 24-inch increments, with seamless water flow between units.







# SPLASH RINGS



74973

74226

74974



73864

73865

73866

- Splash control is critical in small recirculating systems with little water volume
- Atlantic Splash Rings eliminate splash and reduce evaporation, prolonging time between fill ups
- Installed on the top of the basin, Splash Rings add a finished, architectural accent to Colorfalls, Wall Spout and Spillway displays
- Surround Splash Rings with decorative gravel for a finished look
- 304 stainless steel mesh and 3/4" stainless banding deliver years of service

ITEM	74973	73864	74226	73865	74974	73866
MODEL	CFSR12	CFCR12	CFSR24	CFCR24	CFSR36	CFCR36
DESCRIPTION	Stainless Steel Splash Ring for 12" Spillways	Copper Finish Splash Ring for 12" Spillways	Stainless Steel Splash Ring for 24" Spillways	Copper Finish Splash Ring for 24" Spillways	Stainless Steel Splash Ring for 36" Spillways	Copper Finish Splash Ring for 36" Spillways
FINISH	Brushed Stainless	Antique Copper	Brushed Stainless	Antique Copper	Brushed Stainless	Antique Copper
FOR USE WITH	CFBASIN12		CFBASIN24		CFBASIN36	
DIMENSIONS	16"W x 8"D x 1½"H		28"W x 8"D x 1½"H		40"W x 8½"D x 1½"H	
WARRANTY	3-year					





# PROJECT BUNDLES

You provide the hardscape materials, we provide the rest! Atlantic's Project Bundles include all the Atlantic components you need, ready to be assembled into the water feature of your dreams. Build a beautiful Formal Spillway using your choice of stone. Please note products that are included in Project Bundles may not necessarily come in the same box. Online videos make installation easy for contractors and first time builders alike.

## COPPER SPILLWAY BOWL PROJECT BUNDLES

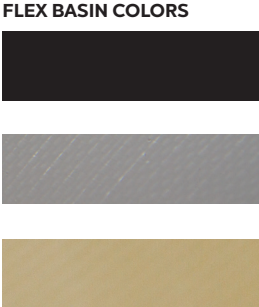

FLEX BASIN COLORS

- Project Bundles are an assembly of all Atlantic components needed to add a water feature to a new or existing hardscape
- Copper Spillway Bowl Project Bundles include 26" Copper Spillway Bowl, Flexible Hardscape Basin, pump, plumbing and glue
- Bundles install directly into 4" x 8" x 12" stone enclosures, but adapt to a variety of engineered stone sizes
- Two Copper Bowl styles, round or square, and three Flexible Hardscape Basin colors accommodate various architectural styles
- Project Bundle shows Copper Spillway Bowl at 22" above water level, but plumbing will accommodate varying heights

ITEM	MODEL	COPPER BOWL	BASIN	PUMP	TUBING
87767	BNDL CB26R12B	CB26R12 - 26" Round Copper Bowl w/12" Spillway	FF4216B - Black 4'W x 2'D x 16"H	TT1500	1½" x 9' Sch 40 Flexible PVC
87768	BNDL CB26R12G	CB26R12 - 26" Round Copper Bowl w/12" Spillway	FF4216G - Grey 4'W x 2'D x 16"H	TT1500	1½" x 9' Sch 40 Flexible PVC
87770	BNDL CB26R12T	CB26R12 - 26" Round Copper Bowl w/12" Spillway	FF4216T - Tan 4'W x 2'D x 16"H	TT1500	1½" x 9' Sch 40 Flexible PVC
87771	BNDL CB26S12B	CB26S12 - 26" Square Copper Bowl w/12" Spillway	FF4216B - Black 4'W x 2'D x 16"H	TT1500	1½" x 9' Sch 40 Flexible PVC
87772	BNDL CB26S12G	CB26S12 - 26" Square Copper Bowl w/12" Spillway	FF4216G - Grey 4'W x 2'D x 16"H	TT1500	1½" x 9' Sch 40 Flexible PVC
87773	BNDL CB26S12T	CB26S12 - 26" Square Copper Bowl w/12" Spillway	FF4216T - Tan 4'W x 2'D x 16"H	TT1500	1½" x 9' Sch 40 Flexible PVC

## COLOR CHANGING COLORFALLS PROJECT BUNDLES



- Project Bundles are an assembly of all Atlantic components needed to add a water feature to a new or existing hardscape
- Color Changing Colorfalls Project Bundles include Color Changing Colorfalls, Formal Spillway Basin, pump, plumbing and glue
- Project Bundles shown with circle stone and 4" x 8" x 12" stone, but adapt to a variety of engineered stone sizes
- Choose from 3 different spillway widths and basin to fit any location
- Project Bundle shows Color Changing Colorfalls at 16" above basin level, but plumbing will accommodate varying heights

ITEM	MODEL	COLOR CHANGING COLORFALLS	BASIN	PUMP	TUBING
87755	BNDL CC12	12" Color Changing Colorfalls	CFBASINKIT12	TT1500	1½" x 9' Sch 40 Flexible PVC
87756	BNDL CC24	24" Color Changing Colorfalls	CFBASINKIT24	TT3000	1½" x 9' Sch 40 Flexible PVC
87757	BNDL CC36	36" Color Changing Colorfalls	CFBASINKIT36	TT4000	1½" x 9' Sch 40 Flexible PVC

## STAINLESS STEEL SPILLWAY PROJECT BUNDLES



### FLEX BASIN COLORS

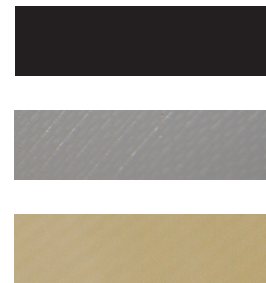

- Project Bundles are an assembly of all Atlantic components needed to add a water feature to a new or existing hardscape
- Spillway Project Bundles include 304 Stainless Steel Spillway, Flexible Hardscape Basin, pump, plumbing and glue
- Bundles install directly into 4" x 8" x 12" stone enclosures, but adapt to a variety of engineered stone sizes
- Two Spillway options, brushed stainless or copper finish, and 3 Flexible Hardscape Basin colors adapt to any design scheme
- Project Bundle shows Spillway at 22" above water level, but plumbing will accommodate varying heights

ITEM	MODEL	SPILLWAY	BASIN	PUMP	TUBING
87762	BNDL SS24B	SS24 - 24" 304 Stainless Steel Spillway	FF4216B - Black 4'W x 2'D x 16"H	TT3000	1½" x 9' Sch 40 Flexible PVC
87763	BNDL SS24G	SS24 - 24" 304 Stainless Steel Spillway	FF4216G - Grey 4'W x 2'D x 16"H	TT3000	1½" x 9' Sch 40 Flexible PVC
87766	BNDL SS24T	SS24 - 24" 304 Stainless Steel Spillway	FF4216T - Tan 4'W x 2'D x 16"H	TT3000	1½" x 9' Sch 40 Flexible PVC
87758	BNDL CS24B	CS24 - 24" Copper Finish Spillway	FF4216B - Black 4'W x 2'D x 16"H	TT3000	1½" x 9' Sch 40 Flexible PVC
87759	BNDL CS24G	CS24 - 24" Copper Finish Spillway	FF4216G - Grey 4'W x 2'D x 16"H	TT3000	1½" x 9' Sch 40 Flexible PVC
87761	BNDL CS24T	CS24 - 24" Copper Finish Spillway	FF4216T - Tan 4'W x 2'D x 16"H	TT3000	1½" x 9' Sch 40 Flexible PVC



**F**

# FOUNTAIN

---

Atlantic's Fountain Systems are the easiest, fastest, and strongest way to build a water feature on or into any horizontal surface. Heavy-duty matched components make setting, plumbing and running your feature simple. Components are designed to work together to beautify any landscape. With systems that will handle any size, any shape and any load, the only limit is your imagination!

- » Systems can be installed in hardscapes or landscapes, in-ground or above-ground, indoors or outdoors for maximum versatility
- » Fountain Basins with integrated internal supports handle more weight with greater stability
- » Two sizes of Three Way Diverters make plumbing and flow control of multiple fountain pieces simple and easy
- » Topside plumbing and tubing channels allow for above water installation and adjustment, no need to get wet
- » Eco-Rise System with Atlantic's Eco-Blox modular reservoirs support any weight, any size, and any number of decorative elements in any configuration







## BASALT COLUMN KITS



73809



92242



73811

- Atlantic Basalt Kits have everything included to create a natural stone water feature with minimal time and effort
- Hexagonal pillars have a sawn base for stability and snapped top that emphasizes the stone's natural beauty
- Volcanic basalt oxidizes to form attractive multi-colored patina over time
- Atlantic's Basalt Columns are generously core-drilled to  $1\frac{3}{8}$ " to fit up to 1" Sch 40 PVC or  $\frac{3}{4}$ " kink-free tubing plus a light cord
- A 2" diameter, 5" deep socket at the top recesses Atlantic's Fountain Light and buffers the water plume
- The plumbing sits directly on top of the basin protected in recessed channels so there is no chance crushing the tubing during installation
- Choose from single 24" and 30" tall Basalt Kits or triple Basalt Kits with 18" to 30" or 24" to 36" columns for installations in a range of locations

ITEM	73809	92242	73811
MODEL	FKNBC24	FKNBCX3-1830	FKNBCX3-2436
DESCRIPTION	24" Natural Basalt Kit	3 Pc Natural Basalt Kit	3 Pc Natural Basalt Kit
ESTIMATED WEIGHT	190 lbs.	399 lbs.	499 lbs.
APPROXIMATE DIMENSIONS	10"W x 24"H	---	
BASIN	FB2400	FB3500	FB4700
PUMP	FP400	TT2000	
PLUMBING KIT	$\frac{3}{4}$ " Kink-free Tubing & (1) Standpipe Sealant	FBKIT3	
WARRANTY	3-year		

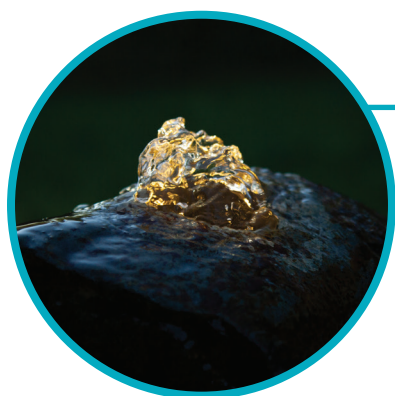

## DID YOU KNOW?

Did you know Atlantic's Basalt Columns have a larger bore hole, a full 2" diameter at the top 5" deep, to minimize splash and turbulence and to accommodate Atlantic's Fountain Light? The rest of the column is bored to a generous  $1\frac{3}{8}$ " diameter, to accommodate  $\frac{3}{4}$ " Kink-free tubing and the cord of the Fountain Light. The epoxy encased Fountain Light generates a warm white flood of illumination at 2800K to integrate perfectly with existing warm white lighting.



## HAMMERED BRASS BOWLS & KIT

### HAMMERED BRASS BOWL KIT



ITEM	92709
MODEL	FKHBB
DESCRIPTION	2 Pc Hammered Brass Bowl Kit - 30/36
TUBING SIZE	25' of 1" & 21" of 1½" Flexible PVC
LINER SIZE	13' x 13'
PUMP VAULT	PV7500
UNDERLAYMENT	(2) 12' x 12'
ECO-BLOX	(5) ECOBLOX-SMALL
ECO-RISE	ECORISE12 & ECORISE20
PUMP	TT4000
WARRANTY	3-year

- Hammered Brass Bowl Kits come with everything needed to create stunning water features in very little time
- Atlantic Hammered Brass Bowls are handcrafted of solid brass in two styles, with matching pedestal for dual bowl installations
- Unlike painted treatments, acid wash finish permanently imparts an attractive, unique patina that will not chip or peel
- Solid brass standpipes create a bubbling fountain effect at the top of both overflowing and spillway styles and support Atlantic Ring Lights
- Dual 1½" inlets allow water supply to be plumbed independently of lighting cords using Atlantic's Cord Seal Fitting
- The secret lies in the newly redesigned Eco-Rise System, with Small Eco-Blox, Pump Vault, Eco-Rise Diverter and Eco-Rises to minimize excavation and effort
- Included Eco-Rise Diverter accommodates Sch40 1" PVC for high flow and maximum durability with single union valves for convenient adjustment
- Includes Triton Check Valve, fittings, teflon tape and glue for complete installation

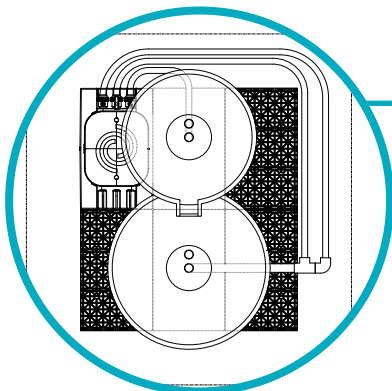

### TECH TIP

To ensure a perfect installation every time, detailed technical drawings precisely outline procedures and specifications. In drawing at left the layout of the components including the tubing, fittings and structural base are all clearly indicated, simplifying installation. Find similar drawings highlighting what you need to know for seamless installation in our Technical Data section. You can find our Hammered Brass Bowl Kit drawing on page 153 in our 2025 Product Catalog.



# AURA VASE KITS



93835



93836



93837



93838



92707



92708

- Aura Vase Kits come with two basin options, each with specially designed fittings, to create stunning water features quickly and easily
- Unlike painted treatments, acid wash finish on hand-hammered solid brass permanently imparts an attractive, unique patina that will not chip or peel
- Solid brass standpipes create a bubbling fountain effect at the top of both overflowing and spillway styles and support Atlantic Ring Lights
- Dual threaded inlets allow water supply to be plumbed independently from lighting cords using Atlantic's Cord Seal Fitting

- In all Kits an individual valve controls flow to each Vase, then its handle removes to prevent tampering
- Single Aura Vase Kits feature Pump, Fountain Basin and Plumbing Kit with discharge elbow and single union valve
- 3-piece Aura Vase Kits utilize Eco-Rise System with Pump, Pump Vault, Small Eco-Blox, 12" Eco-Rise and Plumbing Kit with Triton Check Valve and Eco-Rise Diverter
- Kits include 1" Sch40 Flexible PVC for high flow and maximum durability and custom fittings for complete installation

ITEM	93835	93836	93837	93838	92707	92708
MODEL	FKAV32	FKAVS32	FKAV40	FKAVS40	FKAVX3	FKAVSX3
DESCRIPTION	32" Aura Vase Kit	32" Aura Vase w/ Spillway Kit	40" Aura Vase Kit	40" Aura Vase w/ Spillway Kit	3 Pc. Aura Vase Kit - 24/32/40	3 Pc. Aura Vase Kit w/ Spillways - 24/32/40
BASIN	FB3500		FB4700		---	
PUMP	TT1500	MD1000	TT2000	TT1500	TT4000	TT2000
PLUMBING KIT	FBKIT1				ERKIT3	
LINER SIZE	---				13' x 13'	
PUMP VAULT	---				PV7500	
UNDERLAYMENT	---				(2) 12' x 12'	
ECO-BLOX	---				(5) ECOBLOX-SMALL	
ECO-RISE	---				(3) ECORISE12	
WARRANTY	3-year					

## FOUNTAIN BASINS & ACCESSORIES



74958



92803



92802

- Fountain Basins support decorative features while concealing water reservoir, pump, plumbing and accessories
- Atlantic Fountain Basins are the easiest way for anyone to add a water feature to your landscape, ideal for both the beginners and the professional
- Easily installed. Basins may be set at, above or below grade in landscapes, hardscapes, poolscapes and interiors
- Recessed channels allow fast installation of 1" tubing, up to 1½" in the center channel (FB3500 & FB4700), without fear of kinking and crushing
- Square corners provide more usable area for decorative toppers
- Reinforced injection molded pump access panel provides support without warping or shifting (FB3500 & FB4700)

ITEM	74958	92803	92802
MODEL	FB2400	FB3500	FB4700
DESCRIPTION	24" Fountain Basin	35" Fountain Basin	47" Fountain Basin
DIMENSIONS	24"L x 24"W x 10"H	35"L x 35"W x 13"H	47"L x 47"W x 13"H
MAX PUMP FLOW	750 gph	2,000 gph	4,000 gph
PLUMBING SIZE	Up to ¾"	up to 1½"	up to 1½"
CAPACITY	20 gallons	42 gallons	75 gallons
MAX LOAD	200 lbs.	600 lbs.	1,200 lbs.
WARRANTY		Lifetime	

### FOUNTAIN BASIN FEATURES:

- One-piece rotomolded construction provides exceptional strength.
- Built-in channels protect plumbing below the top of the basin, no crushing or kinking and fit 1½" elbows in the center channel (FB3500/FB4700).
- Closely spaced cones, 19 in the FB4700 and 7 in the FB3500, connect directly to the top panel for greater stability.
- Topside valve pocket holds adjustment valves and 3-Way Diverters to individually adjust flows above water level.
- 1½" conduit recess in perimeter allow for clean installations in surrounding masonry without notching (FB3500 & FB4700).
- Flat panel accommodates optional AF1000 Automatic Fill Valves.

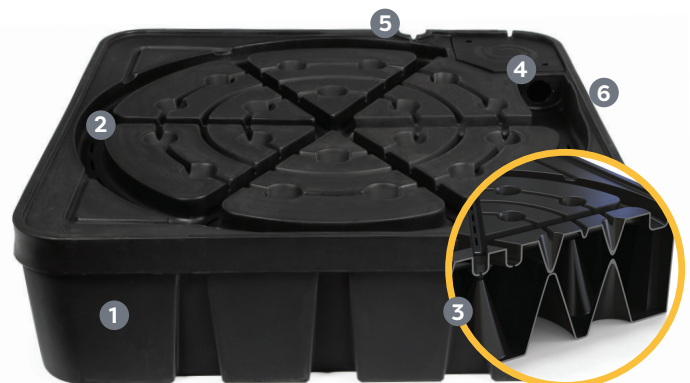

92802 shown



## PLUMBING KITS



93457

- Atlantic's Plumbing Kits facilitate installation and adjustment of flow to decorative toppers with precisely engineered specialty fittings
- Compact 1/2" male thread by spigot elbows mount pumps in Fountain Basins, Vaults and Flexible Basins at exactly the right height
- 1/2" Universal Union with choice of outlets - 1/2" socket, 1/2" male thread or 1" socket - offer unparalleled versatility in mounting and dismantling pumps and toppers



93456

- All components made of Sch40 PVC for complete compatibility with standard fittings
- FBKIT1 includes all necessary fittings to plumb single Aura Vases or other single features on Fountain Basins
- Use FBKIT3 to plumb Basalt Columns or up to three smaller features on Fountain Basins

ITEM	93457	93456
MODEL	FBKIT1	FBKIT3
DESCRIPTION	Fountain Basin Plumbing Kit - Single	Fountain Basin Plumbing Kit - Triple
FOR USE WITH	MD1000 - MD1500 & TT1500 - TT2000	MD1000 - MD1500 & TT1500 - TT3000
VALVE	Single	Triton 3-Way Diverter
TUBING	9' of 1" Flexible PVC	20' of 3/4" Kink-free
STANDPIPE SEALANT	(1) strip	(3) strips
FITTINGS	1/2" Pump Discharge, 1/2" Single Union Ball Valve, 1/2" Universal Union (soc x soc / mpt)	1/2" Universal Union (soc x soc / mpt), 1/2" Pump Discharge, 3-Way Diverter (TR3WAY / 73814)
CORD STOPPER	1/2" for conduit sleeve	
WARRANTY	1-year	



# TECHNICAL DATA

## STAINLESS STEEL & COPPER FINISH SPILLWAY INSTALLATION

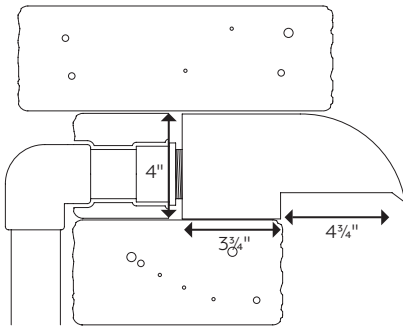

- Spillways are sized to exactly replace 4" tall block
- Load bearing capacity of Spillways is 80 lbs. per linear foot
- Heavier water sheer of Spillways allows taller waterfall height of up to four feet above basin level
- 304 Stainless Steel is not compatible with chlorinated or salt water pools
- 316 Stainless Steel Spillways are for use wherever chlorine is used as a disinfecting agent

### LIGHTING OPTIONS:

- Because the water flow coming out of the Spillways is not laminar, they cannot be lit from within like Colorfalls and Wall Spouts
- To illuminate Spillways, either uplight by placing a Ring Light or Bar Light directly below the falls or downlight by installing wall lights below the Spillway

## WALL SPOUT INSTALLATION

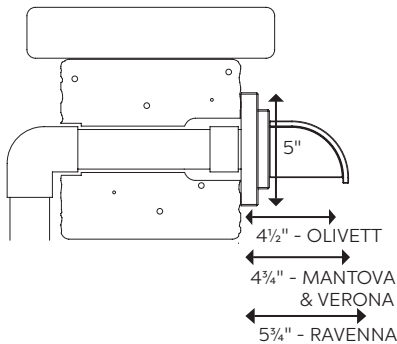

- Wall Spouts should protrude at least 2" over the catch basin
- Integrated drip edge ensures any drip falls straight down preventing water from running back, dampening retaining wall
- Allow for the plumbing to be adjusted backwards to snug the spout against the wall, or caulk small gap between Spout and wall
- Flows under 600 gph will not allow Spout Light to illuminate water flow if used

### LIGHTING OPTIONS:

- To light the laminar flow of water coming out of a wall spout, install an 1/2" tee fitting to supply water to the fixture fitted with a 1/2" x 1" threaded bushing to accept a Warm White or Color Changing Spout Light
- With a minimum of 600 gallons per hour flow, the light will be fully encapsulated within the water illuminating the stream as it travels down to the basin

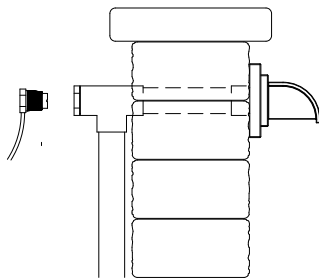

## WATERWALL SPILLWAY INSTALLATION

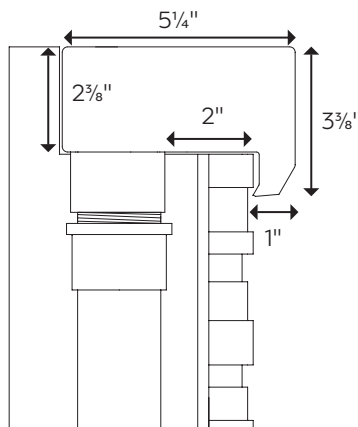

- For framed wall installations, WaterWall Spillway installs on top of framed walls leaving 2" for concrete backer board and fascia
- Liner should cover framing and extend at least 18" to either side of WaterWall
- Bottom of liner must overlap edge of pump basin or reservoir
- Use ball valve on pump to adjust flow
- For masonry installations, a channel may be cut into the course of block below the WaterWall to accommodate 1/2" pipe and fittings

### LIGHTING OPTIONS:

- Two Spotlights submerged at either corner of reservoir will cast light on water cascading down wall enhancing the appearance of movement



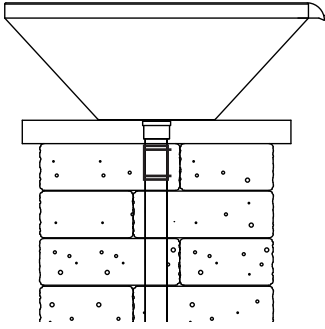

### COPPER SPILLWAY BOWL INSTALLATION:

- Cap and one block in top course need to be removable to access rubber coupling
- Ensure that the spillway lip clears the column to avoid excessive splash and water loss
- For best results and the least amount of water loss, bowl height above reservoir should not exceed 3'

### LIGHTING OPTIONS:

- Use Ring Light around included copper standpipe to illuminate interior of bowl
- Use Cord Seal Fitting in second inlet to pass light cord through bottom of bowl

### COLOR CHANGING COLORFALLS INSTALLATION:

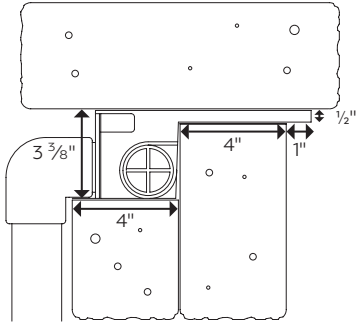

- Colorfalls must be supported evenly both above and below the lip as shown
- Lip overhang should not exceed 1" to avoid algae issues, warping and loss of support
- Load bearing capacity of Colorfalls is 40 lbs. per linear foot
- For best results and the least amount of water loss, falls should not exceed max heights listed on product page

### CONNECTING MULTIPLE COLOR CHANGING COLORFALLS

#### STEP 1.

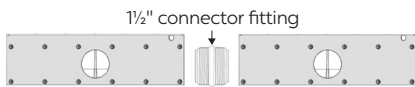

Use included 1 1/2" threaded coupling to attach multiple Colorfalls together.

#### STEP 2.

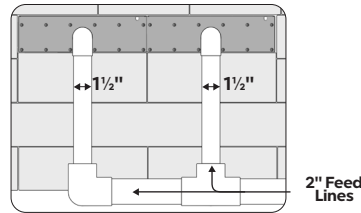

Plumb Colorfalls with 2" manifold or install valves to distribute water equally to all units.

#### STEP 3.

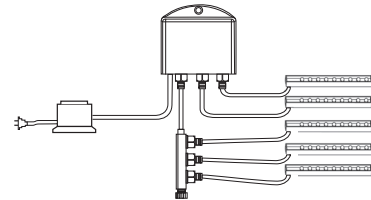

Use Splitters (CCBSX4) and InfiColor Smart Module (CCSM30X3) and larger Transformer to link and sync Color Changing Colorfalls.

**Tip:** Plumb directly into the back center of each unit. Plumbing multiple Colorfalls unevenly favoring one side will produce an uneven water sheer.

# TECHNICAL DATA

## FLEXIBLE HARDSCAPE BASIN PLUMBING KIT (MODEL: FFKIT1 / ITEM: 87754)

Atlantic offers an easy way to plumb Flexible Hardscape Basins and simultaneously hide the pump cord, providing all the components needed to allow the pump cord to exit the basin invisibly. Two Cord Seal Fitting Kits, along with standard tees, allow the cord to pass from inside the basin to the exterior, inside the plumbing itself, without leakage. Once installed, the plumbing can be configured in any configuration desired, while the cord may be removed and replaced as needed.

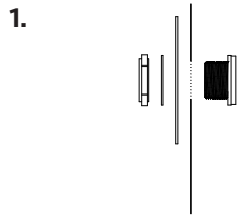

Place the bulkhead fitting and rubber gasket through the hole in the Flexible Basin, threads to the outside. Place the flange and slip washer over the threads, then the nut. Turn COUNTERCLOCKWISE to tighten.

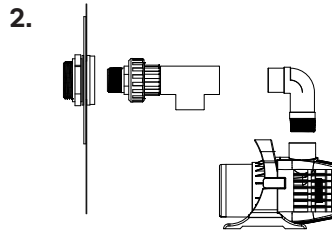

Attach the pump discharge elbow to the TT-Series pump. Hand tighten the assembly and orient the elbow so it is positioned over the pump body. Glue the included nipple into one of the long legs of the tee and glue the tee assembly into the union opposite the threaded end.

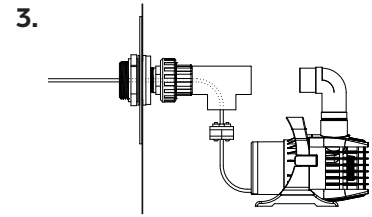

Pass the pump cord into the short leg of the tee and work the cord through the union and the bulkhead fitting. Screw the 1/2" male threaded end of the union into the bulkhead fitting. The Cord Seal Fitting will seal around the pump cord so it can pass through the plumbing without leaking. Disassemble the Cord Seal Fitting and slip the rubber gasket around the pump cord. Reassemble the Cord Seal Fitting ensuring the molded-in nuts are facing towards the tee. Be sure to align the inner and outer halves at 90° to each other and then start the screws.

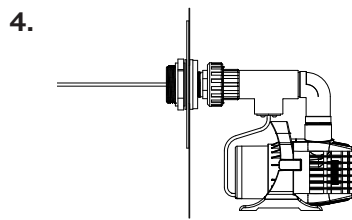

Loosen the union as needed to orient the tee to a convenient position then push the Cord Seal Fitting into the tee, leaving enough slack in the pump cord to allow for pump maintenance and servicing. Tighten the Cord Seal Fitting. Align the tee downwards and tighten the union, then glue the pump discharge elbow into the union assembly.

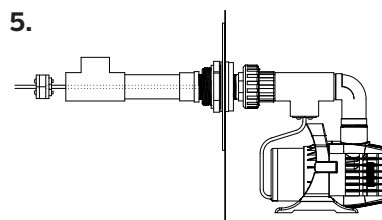

Move to the back side of the wall to finish the remainder of the plumbing work. Slide a male thread adapter over the pump cord, apply silicone to the threads and install the adapter in the bulkhead fitting. Then, measure and cut a piece of pipe to extend from the male thread adapter to the back of the wall. Slide the section of cut pipe over the pump cord and glue into the male thread adapter. Next, slide a tee over the cord and glue that to the section of pipe, aligning the side-outlet of the tee towards the center of the back wall. Disassemble and reassemble a Cord Seal Fitting around the pump cord into the end of the tee.

## FILTRATION OPTIONS

External pressure filters are particularly useful to keep open basins clean. They can be used with the pump set inside or outside the basin. Either way, first install the included bulkhead fitting through the liner following the included instructions. To mount the pump inside the basin, install a pair of tees on the output of the pump both inside and outside of the bulkhead fitting. This will allow the cord to pass through the wall inside the plumbing. Use a Cord Seal Fitting in each tee to seal around the pump cord. To install the pump outside the basin, remove the intake screen of the pump and connect a pipe directly from the bulkhead fitting to the pump intake. Connect the output of the pump to the filter and return the filtered water through the Spout(s) or Spillway to the basin.

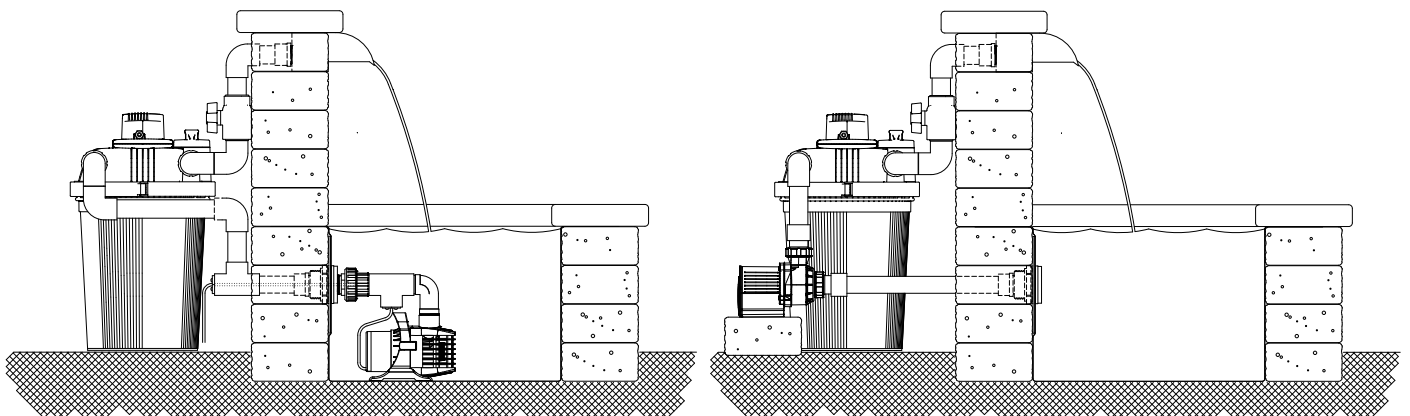



## FORMAL SPILLWAY AND FLEXIBLE BASIN INSTALLS & PLUMBING CONFIGURATIONS

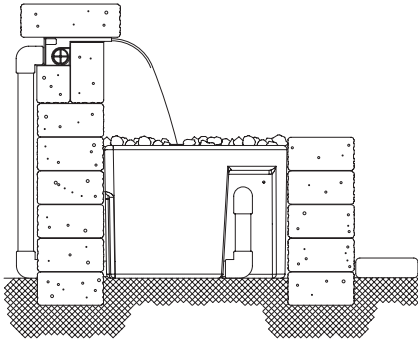

**COLORFALLS WITH FORMAL SPILLWAY BASIN**

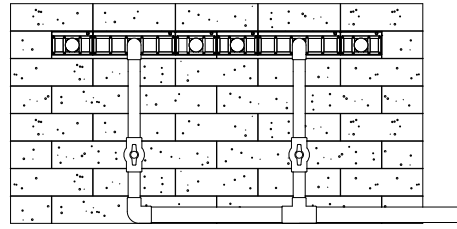

**MULTIPLE COLORFALLS INSTALLATION IN CUSTOM BASIN**

To feed multiple Colorfalls create a manifold of 2" pipe with 1½" risers and valves to balance the flow to two or three Colorfalls. For total flows under 3000 gallons per hour, a single pump may be used; to feed multiple 24" or 36" Colorfalls install a pump at either end of the manifold.

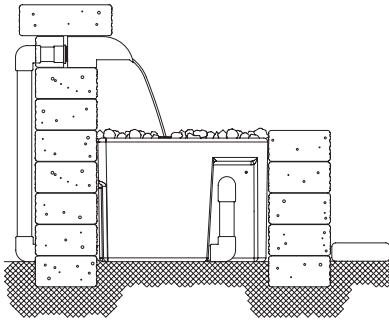

**SPILLWAY WITH FORMAL SPILLWAY BASIN**

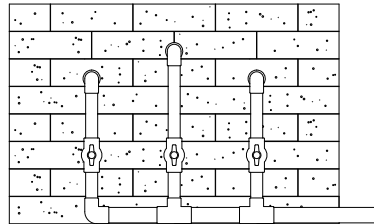

**MULTIPLE SPILLWAYS WITH FORMAL SPILLWAY BASIN**

To feed multiple spillways create a manifold of 2" pipe with 1½" risers and valves to balance the flow to two or three spillways. For total flows under 3000 gallons per hour, a single pump may be used; to feed multiple spillways install a pump at either end of the manifold.

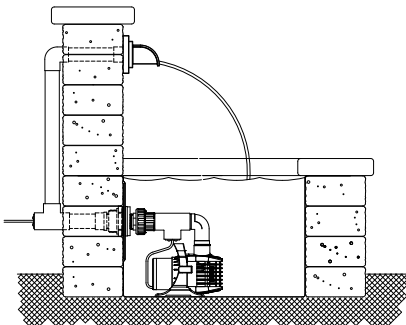

**WALL SPOUT WITH FLEXIBLE HARDSCAPE BASIN**

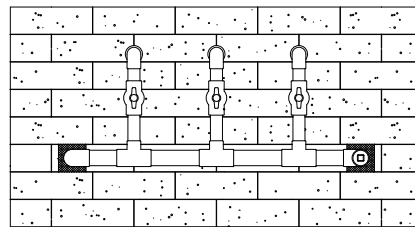

**MULTIPLE SPOUT INSTALLATION IN FLEXIBLE HARDSCAPE BASIN**

To feed multiple spouts create a manifold of 2" pipe with 1½" risers and valves to balance the flow to two or three spouts. For total flows under 3000 gallons per hour, a single pump may be used; for flows over 3000 gallons per hour, install a pump at either end of the manifold.

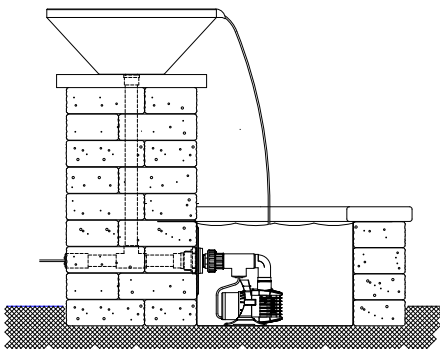

**COPPER SPILLWAY BOWL WITH FLEXIBLE HARDSCAPE BASIN**

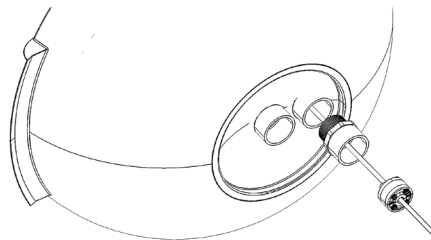

**CORD SEAL FITTING INSTALLATION**

To install Copper Spillway Bowl run plumbing to center inlet and seal secondary inlet with included 1½" Sch40 PVC plug using silicone or tape on threads. If lighting is desired, install 1½" Sch40 PVC male adapter included with Cord Seal Fitting (CSEAL15) in secondary inlet as shown and use Cord Seal Fitting to seal around lighting cord.





125 Lena Drive, Aurora, Ohio 44202  
info@atlantic-oase.com  
1.330.274.8317

[www.ATLANTIC-OASE.com](http://www.ATLANTIC-OASE.com)